

All-in-One Walking Trainer User Manual

25-20035, 25-20526



General on the walking trainer

Index

General on the walking trainer		3
Operation	General	4
	Charging the battery	4
	Safety function, lifting motor	5
	Emergency stop	5
	Emergency lowering	5
	Brakes	5
Lift using the walking trainer	General	6
	Lift from wheelchair/chair	6
Walking training	General	7
	Placing in wheelchair/chair	7
Mounting instructions	25-20035, 25-20526, 25-20135	8
	Mounting of steering device	9
Technical information		10
Maintenance	Daily check	13
	Cleaning	13
	Monthly maintenance	13
	Annual inspection	13
Trouble shooting		14
Declaration of conformity		15
Claims deadline and service		16

In case of inquiries concerning spare parts and service, please state the following information:

Customer: _____
Walking trainer _____
model: _____
Serial number: _____
Year and month: _____
Max. load: _____

Producer

Ropox A/S

Ringstedgade 221

DK-4700 Næstved

Tel.: +45 55 75 05 00

Fax: +45 55 75 05 50

info@ropox.dk

www.ropox.dk

Distributor

General on the walking trainer

NOTE! It is important for the user to be familiar with the operation of the walking trainer and its facilities and that it performs without problems. Therefore, in order to obtain optimum safety this Manual must be read carefully before use.

Ropox A/S shall only be responsible for the safety, reliability and performance of the walking trainer if the following instructions are observed:

- The walking trainer must be assembled and connected according to our instructions.
- The walking trainer must be used and cleaned as described in this Manual.
- The walking trainer must only be used indoor.
- The walking trainer must be subjected to service at least once a year, according to the procedures of the "Service Manual".

The walking trainer is designed to lift a person from chair and bed (in seated position) and subsequent walking training.

NOTE! UNDER NO CIRCUMSTANCES should the walking trainer be used for lifting objects other than persons – and only persons, whose weight, including the lifting sling, does not exceed the maximum load stated. In the event of loads exceeding the maximum value prescribed or lifting of objects other than persons Ropox A/S shall disclaim any responsibility in connection with insurance, right to complain and service.

Users should always make sure that the mechanical and electrical systems of the walking trainer work satisfactorily. In case of malfunction the walking trainer must be stopped immediately and inspected or repaired, as required. Malfunction may be a symptom of defects that may get worse and jeopardise the safety in critical situations

The battery should be charged at regular intervals to ensure that the walking trainer is always operational (e.g. every night).

Warning! or **Note!** means that the text contains important safety and operating instructions, which must be observed in order to avoid accidents.

CE The walking trainer has CE-marking and thus meets the functional and safety requirements of the Directives for Medical Devices, Low Voltage and EMC. See Declaration of Conformity, page 15. The product is in risk group 1.

It has been tested by the Danish Centre for Assistive Technology according to the rules of Standard DS / EN ISO 10535, „Hoists for the transfer of disabled persons – requirements and test methods“. All electrical components meet current electrical standards.

Operation

General

1. Check that the emergency stop has been released, If not, turn the button clockwise until release.
2. The walking trainer is operated by means of the hand control unit. The two upper buttons control the lifting/lowering movement, whereas the two lower buttons control the leg spreading facility. It is not possible to use two functions simultaneously.

Note! In case of maloperation of the hand control unit (e.g. too quick change of direction) the hoist does not react. Let go of the push button, wait a few seconds and press the button again.

3. It is important to use the correct sling for the specific purpose. Further instructions concerning the use of slings will be found in the “Walking Trainer User Manual for Slings”.
4. The battery should be charged regularly to ensure that the walking trainer is always operational (e.g. every night).

Emergency

Only use the emergency stop and emergency lowering device (electrical or mechanical) in case of an emergency situation. Should it be necessary to use the emergency functions, always contact the distributor before using the walking trainer again.

Charging the battery

- The battery **must** be charged when an acoustic signal is heard from the control unit. This will happen when the battery capacity is 50%. The walking trainer may still be used, but the recharging capability of the battery will be reduced.

Note! For the 150 kg walking trainer this corresponds to approx. 60 lifting operations and for the 200 kg walking trainer to approx. 30 lifting operations.

- We recommend charging the walking trainer when it is not being used for a longer period of time, e.g. every night. The battery cannot be over-charged and it is “healthy” for it to be charged often as the lifetime will be increased.
- The battery is charged directly in the control unit by means of the mains cable provided. Insert the cable in the wall outlet and the control unit, see drawing page 11, and switch on power. The walking trainer cannot be used when connected to mains voltage.
- A green lamp on the control unit indicates that mains voltage has been connected. A yellow lamp indicates that the battery is being charged.
- When the battery has been fully charged the light of the yellow lamp will go out.
- Battery charging takes approx. 4-5 hours.
- When charging the battery using a wall-mounted charging station (optional) an extra battery may be constantly charged. Changing battery is easy owing to the snap-system on top of the battery box.

Operation

Safety function, lifting motor

The lifting motor is provided with a safety device protecting against jamming. If the lifting arm meets with resistance during lowering, the movement of the arm will stop automatically. Thus, a person cannot get jammed between the lifting arm and the bed/chair.

Warning!!

Owing to the protection facility of the motor the lifting arm may fall freely to the spindle of the motor.

Therefore, make sure that the lifting arm does not "hang", that it has always been pressed down to ensure that it rests on the spindle of the motor before and after all lifting operations.

This is important as otherwise persons may get hurt if the lifting arm "falls" down.

Emergency stop

If the walking trainer must be stopped in an emergency, press the red button of the control unit. When the button has been depressed, the electrical functions cannot be activated and the battery indicator has been switched off.

Emergency lowering

If the walking trainer is to be lowered and the hand control unit does not work, there are two possible solutions:

- The electrical emergency lowering device of the control unit (marked emergency), see drawing page 11. Press it with a ball pencil or the like and the person will be lowered slowly.
- The mechanical emergency lowering device of the lifting motor. Pull the red handle, see drawing page 10.

Brakes

The walking trainer may be braked by means of the two large rear wheels by using the foot to press down the rear part of the brake. The brake may be released by using the foot to press down the front part of the brake.

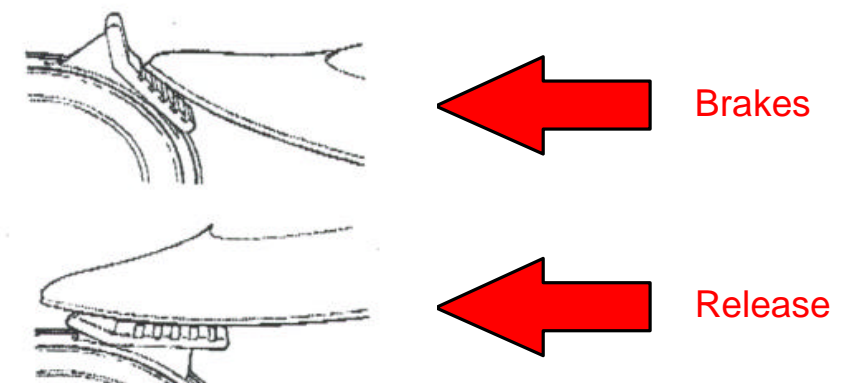

Lift using the walking trainer

General

- Before lifting a person it is important to be familiar with the walking trainer and that it works satisfactorily.
- Also, it is important to choose the right size of sling for the lifting operation to be performed. Further information about the use of slings will be found in the "Walking Trainer Manual for Slings".
- We recommend that the walking training take place on a horizontal surface. However, the walking trainer may be used on surfaces with gradients up to 5°.
- Never lift a person higher than necessary.
- Always observe the maximum load of the hoist.

Try the walking trainer on yourself before lifting or training another person.

Lift from chair/wheelchair

- Place the sling around the client sitting in the chair/wheelchair. Close the body belt and tighten it so that it is still comfortable.
- Place the leg straps between the thighs and pull the lifting straps placed in front of the shoulders through the black loops of the leg straps. Make sure that the four grey lifting straps are in the same height before attaching them to the spreader bar.
- Increase the width between the legs of the hoist and move it towards the client.
- Place the feet of the client on the floor.
- Move the hoist so close to the client as possible.
- Make sure that the spreader bar is in the lower position.
- Place the lifting straps of the sling correctly in the hooks of the spreader bar. Check that all straps have been fitted correctly.
- Lift the client a few centimetres above the seat - STOP – and make sure that the sling is placed correctly.
- When the client is comfortable, lift him/her from the chair to standing position.
- Slowly pull the hoist away from the chair - STOP – adjust the sling and lifting height until the client is standing comfortably.
- You may now start walking training.

Note! The wheelchair must be locked in connection with transfer to and from chair.

Walking training

General

The carer may walk in front of or beside the walking trainer, instructing or supporting the client.

Raising or lowering the sling frame will relieve the client depending on the phase of walking training.



Use the hand support to begin with in order to give the client something to hold on to and to use for pushing/steering.

During the last phase of the walking training the client may use the hand support only without the support of the sling.

The steering devices of the two front wheels contribute to steering the walking trainer, e.g. when persons with hemiplegia start walking training.

Placing in chair/wheelchair

To place a person in a chair/wheelchair, do the procedures on the opposite side in reverse order:

- Increase the width between the legs of the walking trainer and move it to the chair.
- Make sure that the client is positioned correctly above the chair and lower the hoist slowly.
- Check that the client is positioned correctly during the entire operation.
- When assisting a client in getting back into the chair, lower the client so that he/she just touches the chair.
- If the chair can be tilted a little backward it is easier to place the client correctly.
- If two assistants are present, one may press gently on the knees of the client.

Mounting Instructions

Assembly of:

25-20035 Walking Trainer 150kg

25-20526 Walking Trainer 200kg
and

25-20135 Walking trainer unit

Note! Assembly of 150kg and 200kg Walking Trainers is identical. The only difference is the undercarriage.

- Place the lifting mast in the mast holder on the undercarriage. Tighten the two screws using the 5mm Insex wrench provided.
- Insert the cable of the leg spreading motor into outlet terminal 2, see "Technical Information", page 11.

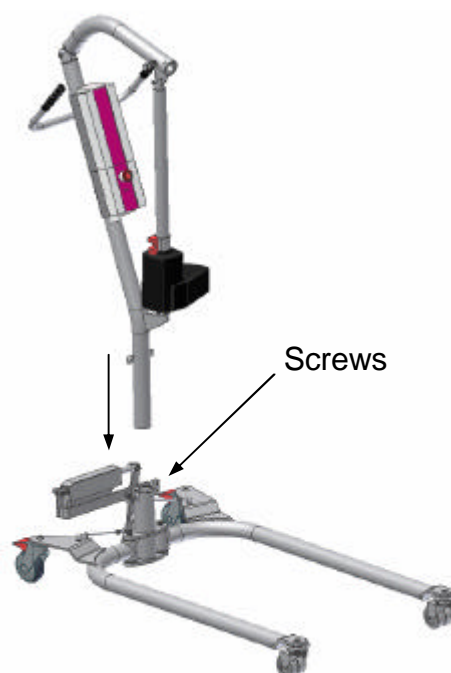

Assembly of lifting unit and hand support:

- Brake the rear wheels.
- Hold the lifting unit (turn it through 90°) so that the locking pin may be pushed into the corresponding slide rail of the lifting mast.
- Push in the lifting unit.
- Now turn it 90° clockwise until a click is heard from the locking screw.
- Check that the arm has been properly locked.
- Hook the hand support on to the mast holder.
- Tighten the tightening handle on the side.

The walking trainer is now ready for use.



Mounting Instructions

Dismounting

- Brake the rear wheels.
- Loosen the tightening handle.
- Note! Do not unscrew it completely.
- Lift the hand support off the mast holder.
- Note! It may be stuck owing to the clamping plates.
- Pull the locking screw while turning the spreader bar 90° counter-clockwise.
- The lifting unit may now be pulled out

Note! Be aware of the weight of the lifting unit.

Mounting of directional steering of the front wheels

- Dismount the M10x45 countersunk screw with washer and nut keeping the wheel in place.
- Mount plate and holder for steering using the new M10x50 countersunk screw.

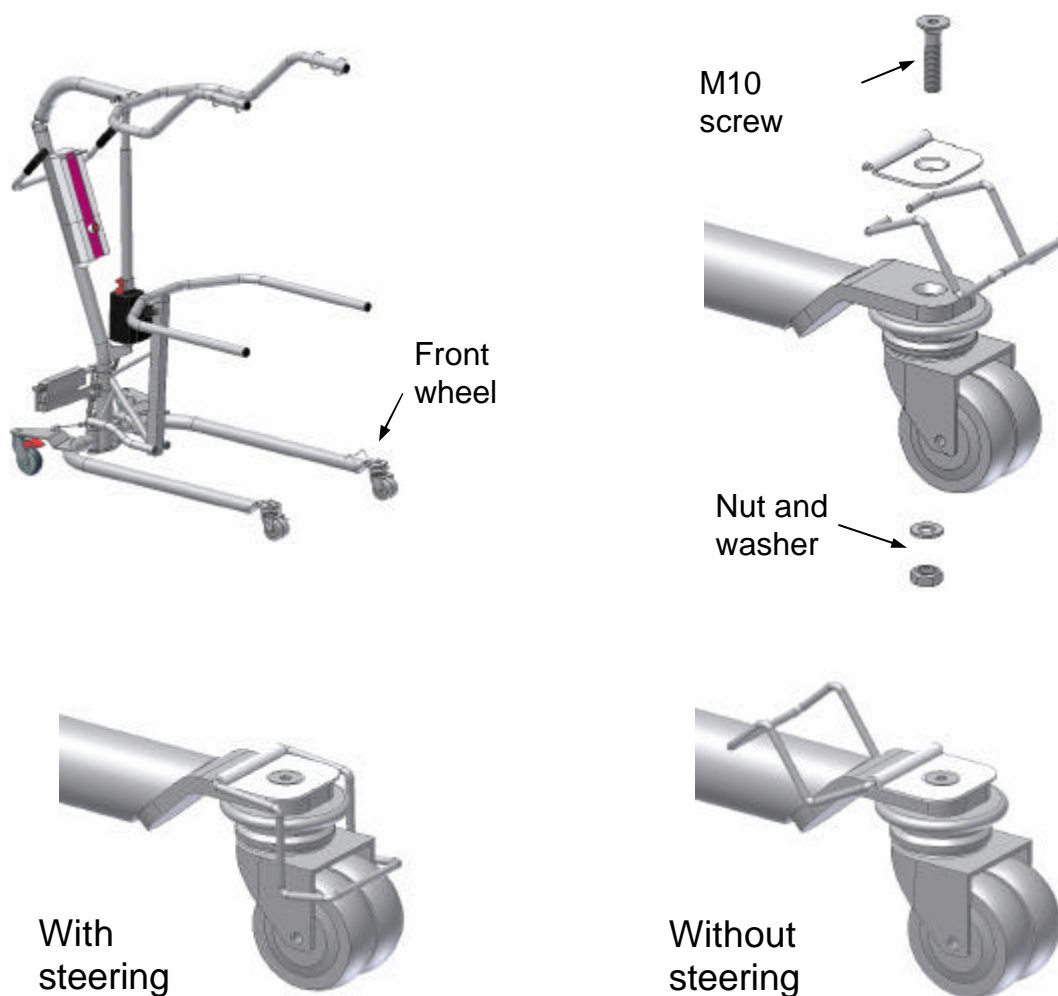

Technical information

Frame

Material: St.37
Surface: Powder-coated in the colours RAL 4006 traffic purple, RAL 4007 purple violet and PHM 7812/CWS black.

Wheels

Front: Diameter Ø75 mm double-wheels with directional stabilisation.
Rear: Diameter Ø100 mm with brake.

Motors

	Lifting motor	Leg spreading motor
Type designation	LA34.4	LA12.1
Power consumption, max.	10A	3.2A
Pushing force	7500 N	750 N
Speed unloaded	15 mm/s	14 mm/s
Speed loaded	9 mm/s	6 mm/s
Protection	IP66	IP65

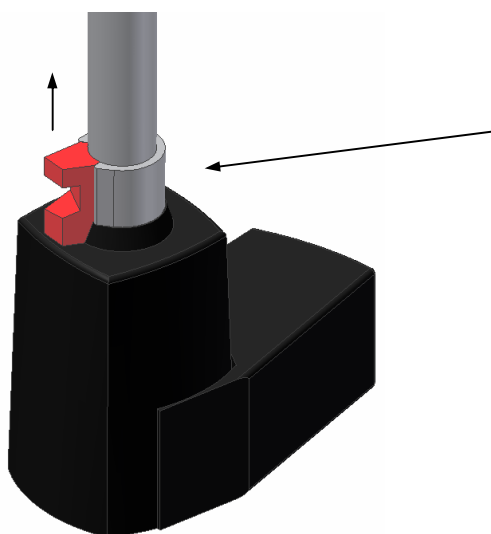

The lifting motor has mechanical emergency lowering. To release the device, pull the red handle.

Hand control unit

Type designation HB52B

The hand control unit has two functions.
The two upper buttons control the lifting/lowering movement.
The two lower buttons control the leg spreading facility.



Technical information

Control unit

Type designation	CBJ2, (150/200kg)
Mains voltage	100-240V
Output voltage	24V DC
Max. output current	10,8A
Protection	IP65

Note! The control units of the 150kg and 200kg walking trainers are not identical. Therefore the serial number of the product must be stated when ordering a new control unit.

The electrical system is designed for periodical use with a duty circle of max. 10% conforming to 1 min. active/ 9 min. pause.

1. Emergency stop
2. Emergency lowering
3. Charging indicator
4. Connected to mains voltage
5. Socket for remote control
6. Socket for lifting motor, output terminal 1
7. Socket for leg spreading motor, output terminal 2
8. Socket for charging, mains cable

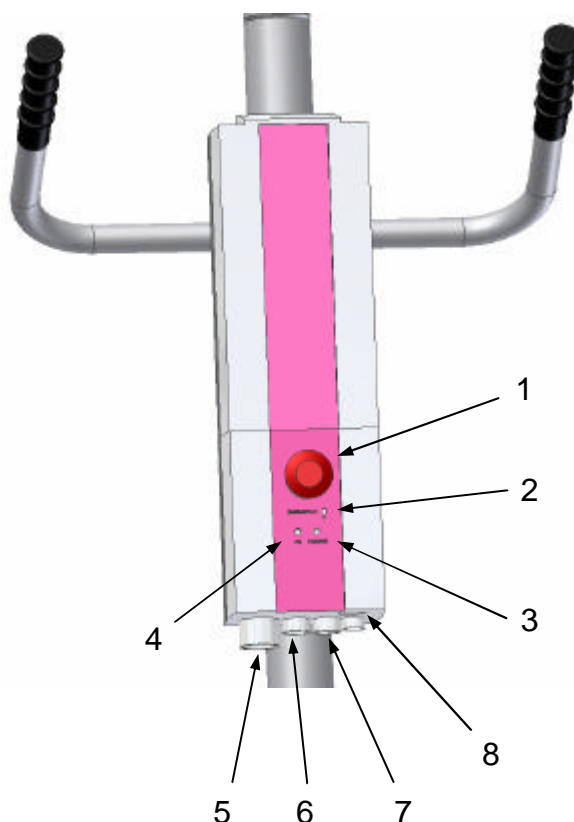

The control unit is provided with:

- Protective motor switch for lifting and leg-spreading, protecting against overloading
- Short-circuit protection
- Acoustic signalling device sounding when the battery must be charged
- Electrical emergency lowering device to be used if the hand control unit does not work
- Built-in charger

Battery

Type designation	BAJ1
Output voltage	24V DC, 2.7 Amps.
Protection	IP65

The battery is placed directly on the control unit. When the capacity is approx. 50% the control unit beeps during operation and the battery must be charged. Charging takes 4– 5 hours.

Note! The walking trainer cannot be used during charging.

Technical information

<u>Dimensions</u>	25-20035 150kg	25-20526 200kg
Lifting capacity	150 kg	200 kg
Min. lifting height, lifting hook	150 cm	150 cm
Max. lifting height, lifting hook	190 cm	190 cm
Lifting travel	40 cm	40 cm
Min. height of handle	75 cm	75 cm
Max. height of handle	105 cm	105 cm
Width of handle	65 cm	65 cm
Length of undercarriage	117 cm	122 cm
Length legs	97 cm	98 cm
Min. inside distance between legs	50 cm	54 cm
Max. inside distance between legs	94 cm	118 cm
Min. outside distance between legs	65 cm	69 cm
Max. outside distance between legs	109 cm	133 cm
Height of undercarriage	12 cm	12 cm
Free height under legs	7 cm	7 cm
Wheel diameter	100/75 cm	100/75 cm
Turning circle	125 cm	131 cm
<u>Weights</u>		
Weight of spreader bar (lifting unit)	5.0kg	5.0 kg
Weight of handle unit	8.5 kg	8.5 kg
Weight of battery	3.0 kg	3.0 kg
Total weight	55.0 kg	61.5 kg
Approx. number of lifting operations per charging	60	30

Maintenance

Always make sure that the mechanical and electrical systems of the walking trainer operate satisfactorily. In case of malfunction stop the walking trainer and check or repair it, as required. Malfunction may be a symptom of defects that may get worse and jeopardise the safety in critical situations. It is therefore important to check the walking trainer as described below.

Daily check

- Slings
1. Check that the slings are clean. If not, have them washed. See washing instructions on the Quick-guide  sewn on the sling.
 2. Make sure that they are not worn and that the seams are intact and not frayed. Worn slings must be replaced.
- Hoist
3. Check that the hand control unit works satisfactorily and that it has been mounted correctly.
 4. Check that cables have been inserted correctly into the control unit.
 5. Check visually that shaft and bolted joints run smoothly and without noise.
 6. Keep the walking trainer clean. A clean product is safer and has a longer life.

Cleaning

- Clean the walking trainer with a damp cloth wrung in warm water with a mild detergent.
- Electrical components may be wiped with a firmly wrung cloth. Avoid water on these components.
- Never use solvents.

Monthly maintenance

- Slings
1. Inspect the slings thoroughly and replace them in case of visible defects or wear.
- Hoist
2. Check that the hand control unit, control unit and battery have no visible defects.
 3. Check that cables have been inserted correctly and are undamaged.
 4. Check that the lifting motor has not been bent and is undamaged.
 5. Check that all shafts and bolted joints are intact and stable. Worn parts should be replaced.
 6. Check the wheels for smooth running and clean them once a month.

Annual inspection

Preventive service **must** be carried out once a year, following the procedures of the "Service Manual".

Trouble shooting

If the walking trainer does not operate satisfactorily, check and test the following functions before contacting an authorised distributor.

1. Has the battery been charged?
2. Has the emergency stop been released?
3. Have all plugs been inserted correctly?
4. Has the hand control unit been mounted correctly and is it in working order?
5. Try another hand control unit or control unit.
6. If the lifting arm cannot be lowered using the hand control unit, use the electrical or mechanical emergency lowering device, see page 5, to lower the lifting arm.

<u>Symptom</u>	<u>Possible cause</u>	<u>Action</u>
Indicator for mains voltage does not light up during charging	<ul style="list-style-type: none"> - Mains voltage not connected - Control unit defective 	<ul style="list-style-type: none"> - Connect mains voltage - Replace control unit
The motors are not operating. A click is heard from the relays of the control unit	<ul style="list-style-type: none"> - The plug has not been inserted correctly into the control unit - Motor defective - Control unit defective 	<ul style="list-style-type: none"> - Insert plug into the control unit - Replace motor - Replace control unit
The motors are not operating. No click is heard from the relays of the control unit	<ul style="list-style-type: none"> - Control unit defective - Hand control unit defective 	<ul style="list-style-type: none"> - Replace control unit - Replace hand control unit
The control unit is completely “dead”. No click is heard from the relays of the control unit	<ul style="list-style-type: none"> - The battery has been run down - The battery is defective 	<ul style="list-style-type: none"> - Charge battery - Replace battery
The control unit is OK except for one direction in one channel	<ul style="list-style-type: none"> - Hand control unit defective - Control unit defective 	<ul style="list-style-type: none"> - Replace hand control unit - Replace control unit

Declaration of conformity

EU – Declaration of conformity



The undersigned hereby declares that the following All-in-One products:

25-20035 All-in-One, 150kg, Walking Trainer, convertible
25-20526 All-in-One, 200kg, Walking Trainer, convertible

with the following accessories:

25-20135 Walking trainer unit for All-in-One
25-29950 Wall-mounted charging station

all belong in risk class I and are in conformity with the following directives and standards:

DIRECTIVES

- EU Council Directive No. 93/42EEC concerning Medical Devices, modified by Directive No. 98/79/EC
- 73/23EEC, The Low Voltage Directive, modified by 93/68/EEC
- 89/336/EEC, EMC-Directive, modified by Directives 92/31/EEC and 93/68/EEC

STANDARDS

DS/EN	980:2003	DS/EN	292-1:1993
DS/EN	1041:2000	DS/EN	292-2:1993
DS/EN ISO	14971:2001	DS/EN	614-1:1998
DS/EN ISO	10535:2007	DS/EN	1021-1:1994
DS/EN	12182:2002	DS/EN	1021-2:1994
DS/EN ISO	9999:1999	DS/EN	ISO 3741:1999
DS/EN	60601-1+A1,2, 13+CORR:1996	DS/EN	ISO 3744:1995
DS/EN	60601-1-2:1995		

Date: 10-11-2008



Tommy Jensen
Adm. direktør

Claims deadline and service

Claims deadline

See General Terms of Sale and Delivery on www.ropox.dk

The right to complain shall not apply if the product is not subjected to service inspection at least once a year according to the procedures described in the "Service Manual".

Remedy of defects must always be carried out by an authorised Ropox distributor.

Service

Always make sure that the mechanical and electrical systems of the walking trainer operate satisfactorily. In case of malfunction, stop using the product and inspect or repair it, as required. Malfunction may be a symptom of defects that may get worse and jeopardise the safety in critical situations.

Preventive service **must** be carried out once a year, following the procedures of the "Service Manual".

Service and repairs must always be carried out by trained and competent personnel.

We recommend registration in a log book for each walking trainer in connection with service visits to be used as documentation in case of complaints.

Only use original spare parts and accessories.

Modifications of the walking trainer must be carried out by authorised Ropox personnel.



ROPOX A/S

Ringstedgade 221
DK – 4700 Naestved
Denmark

Tel.: +45 55 75 05 00 Fax.: +45 55 75 05
50

E-mail: info@ropox.dk
www.ropox.com