

”A table frame that makes kitchens more accessible”



ROPOX FLEXIPLUS & FLEXIPLUSCORNER

A QUIET, HEIGHT-ADJUSTABLE TABLE FRAME DESIGNED FOR ACCESSIBLE KITCHENS

FlexiPlus is a height-adjustable table frame that comes with a 300 mm adjustment range as standard. If required, it is possible to programme the height adjustment to an even larger range, from 0-660 mm.

The table frame is an improved version of the FlexiElectric table frame. With FlexiPlus you get a more quiet height adjustment, an elegant cover of mounting screws, a more flexible placing of legs and fewer components. Also, you can get a control device with a key lock or as a remote control.

The built-in ROPOX Sicuro anti-collision is an extra safety feature. If you choose to add the safety stop list on the front edge of the worktop, you can avoid trapping risk when operating the table.

If the existing piping hinders the mounting of the table frame, you can install FlexiPlus with protruding legs using distance brackets. This way, you get more room on the worktop, e.g. for sink or hotplates.

On FlexiPlus you can level out the worktop in three dimensions. This allows you to accurately adjust the worktop and get it plumb and level.



The Ropox Connect app allows you to set FlexiPlus to a specific height via Bluetooth wireless technology.

ROPOX FLEXIPLUS/CORNER

Max. load: 150 kg evenly distributed
 Height: 65-95 cm
 Length: 60-300 cm
 Colour: RAL 9010
 Adjustment: 0-30 cm (possible 0-66 cm)

FLEXIPLUS – standard frame for worktop



FLEXIPLUS – frame including worktop and fascia

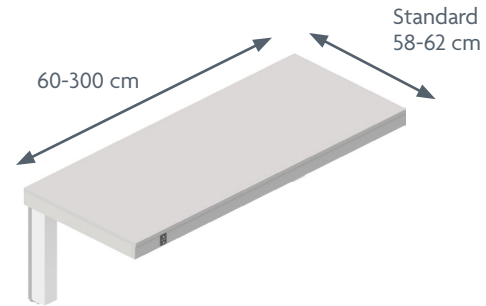

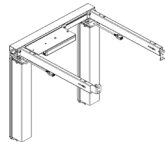
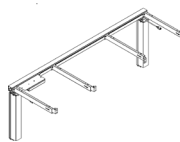
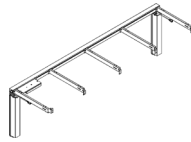
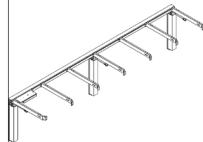
MODELS/ITEM	30-90060/ 30-90100	30-90105/ 30-90200	30-90205/ 30-90240	30-90245/ 30-90300
LENGTH OF WORKTOP	60-100 cm 	105-200 cm 	205-240 cm 	245-300 cm 

FLEXIPLUS CORNER, 90° corner angle

Item: 30-91001
 Item: 30-91002



FLEXIPLUS CORNER, 90° up to 160° corner angle

Item: 30-93000



ACCESSORIES

Support arm
 depth 38-72 cm
 Item: 30-67619 to 30-67627



Support foot, 49 cm
 to relieve the wall
 Item: 30-67705

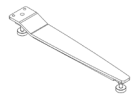

Bracket, 7 cm
 space to wall
 Item: 30-90530

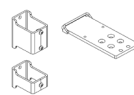

Height adjustable
 programming, 0-66 cm
 Item: 30-93700

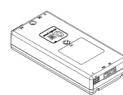

Double Safety
 Item: 30-90580

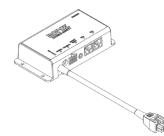

Safety stop
 length 120-620 cm
 Item: 30-92120
 to 30-92620



Control, wireless
 Item: 30-90540



Control, with lock
 Item: 30-90550



Fitting for panels
 Item: 30-67760

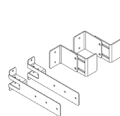

Cover for plumbing
 Item: 30-67635

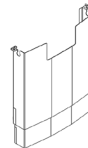

Corner bracket, 90°-160°
 Item: 30-90570

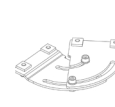

NB! Find more information about measurements, technical data, installation interfaces and much more under the product and in the instruction manuals on our website.

The items are produced according to the following Standard: DS / ISO 17966:2016

ROPOX A/S · Ringstedgade 221 · 4700 Naestved, Denmark – Phone: +45 5575 0500 · info@ropox.com · www.ropox.com

ROPOX™
 BETTER WAYS TO BETTER DAYS

– A PART OF AddLife®